



EPSRC

Introduction to OpenMP

Lecture 1: Shared Memory Concepts



Overview

- Shared memory systems
- Basic Concepts in Threaded Programming



Shared memory systems

- Threaded programming is most often used on shared memory parallel computers.
- A shared memory computer consists of a number of processing units (CPUs) together with some memory
- Key feature of shared memory systems is a *single address space* across the whole memory system.
 - every CPU can read and write all memory locations in the system
 - one logical memory space
 - all CPUs refer to a memory location using the same address



Conceptual model

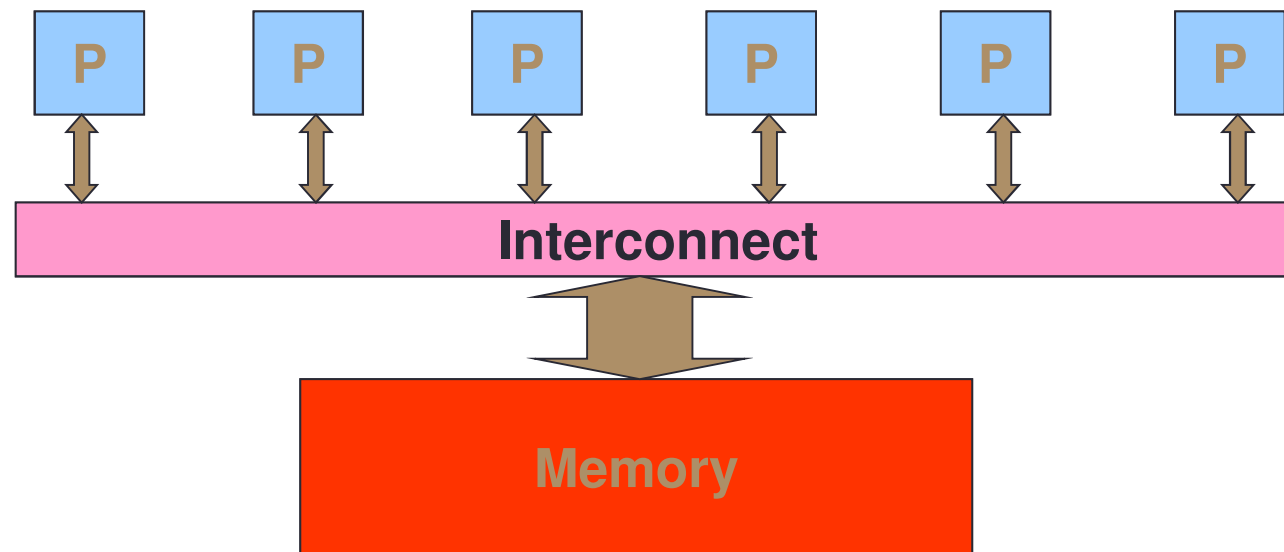

Real hardware

- Real shared memory hardware is more complicated than this.....
 - Memory may be split into multiple smaller units
 - There may be multiple levels of cache memory
 - some of these levels may be shared between subsets of processors
 - The interconnect may have a more complex topology
-but a single address space is still supported
 - Hardware complexity can affect performance of programs, but not their correctness



Real hardware example

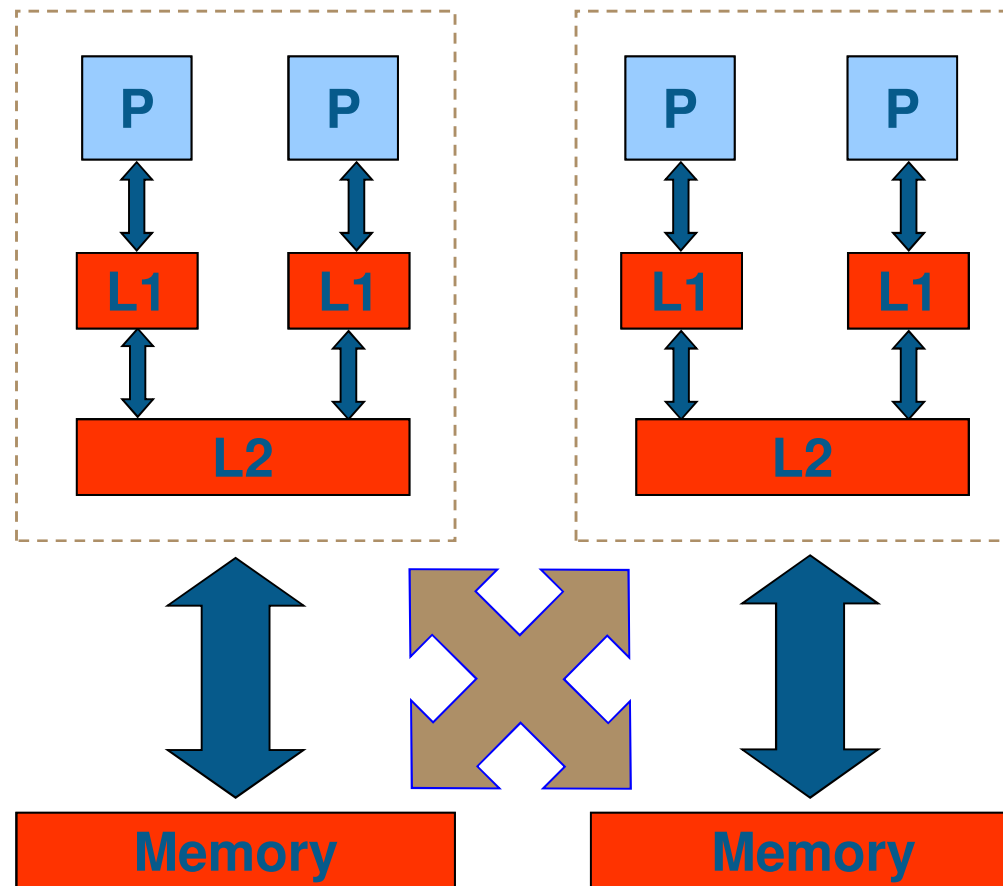

Threaded Programming Model

- The programming model for shared memory is based on the notion of threads
 - threads are like processes, except that threads can share memory with each other (as well as having private memory)
- Shared data can be accessed by all threads
- Private data can only be accessed by the owning thread
- Different threads can follow different flows of control through the same program
 - each thread has its own program counter
- Usually run one thread per CPU/core
 - but could be more
 - can have hardware support for multiple threads per core



Threads (cont.)

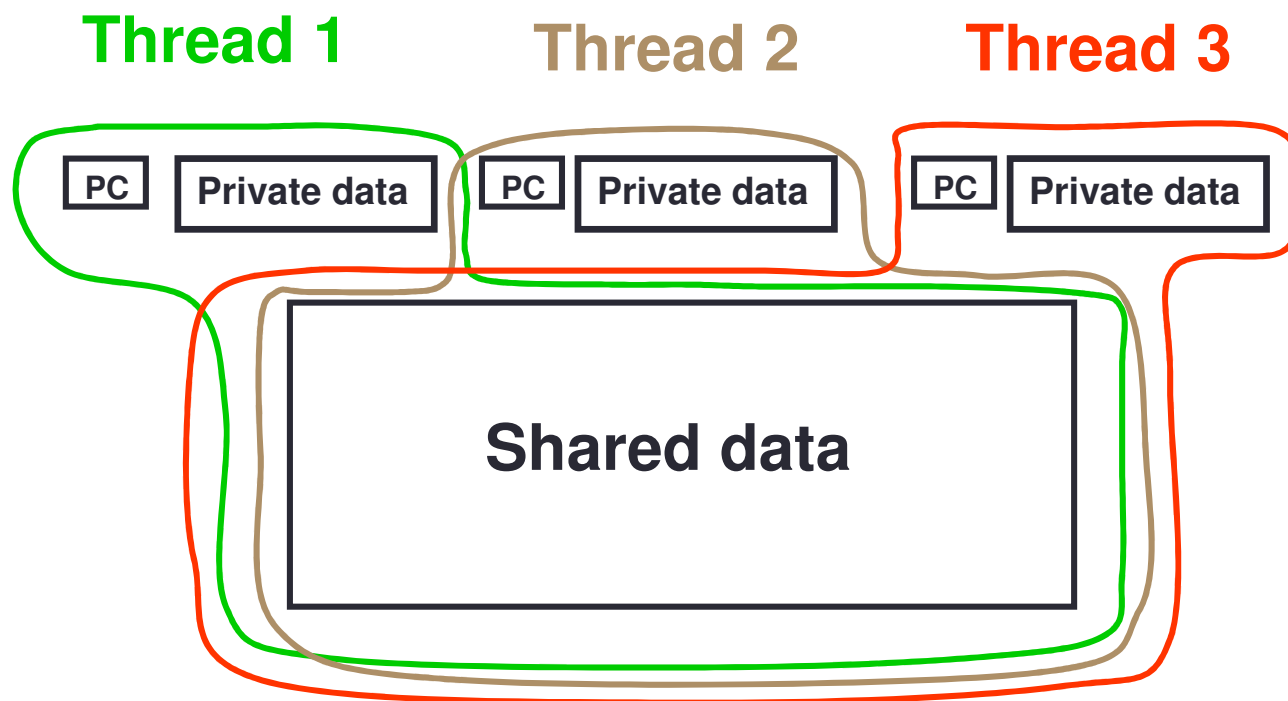

Thread communication

- In order to have useful parallel programs, threads must be able to exchange data with each other
- Threads communicate with each via reading and writing shared data
 - thread 1 writes a value to a shared variable A
 - thread 2 can then read the value from A
- Note: there is no notion of messages in this model



Thread Communication

Thread 1

Thread 2

Program

`mya=23`
`a=mya`

`mya=a+1`

Private data

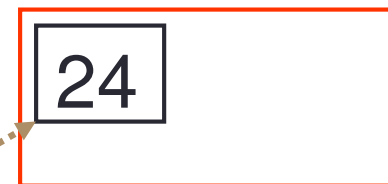
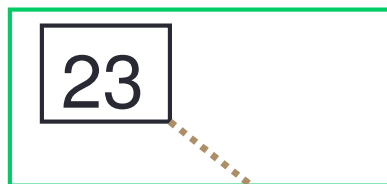

Shared data

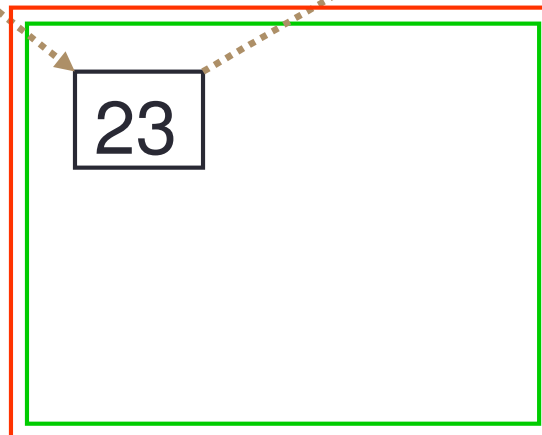

Synchronisation

- By default, threads execute asynchronously
- Each thread proceeds through program instructions independently of other threads
- This means we need to ensure that actions on shared variables occur in the correct order: e.g.

thread 1 must write variable A before thread 2 reads it,

or

thread 1 must read variable A before thread 2 writes it.

- Note that updates to shared variables (e.g. $a = a + 1$) are *not* atomic!
- If two threads try to do this at the same time, one of the updates may get overwritten.



Synchronisation example

Thread 1

Thread 2

Program

load a
add a 1
store a

load a
add a 1
store a

CPU
Registers

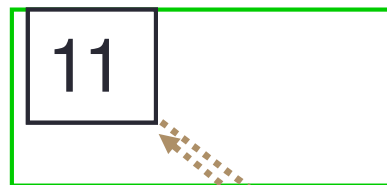

Memory

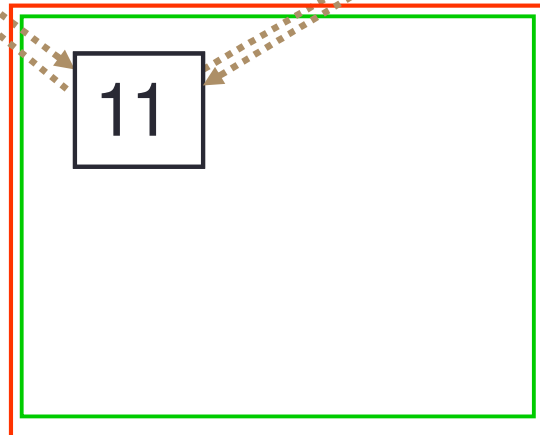

Tasks

- A *task* is a piece of computation which can be executed independently of other tasks
- In principle we could create a new thread to execute every task
 - in practise this can be too expensive, especially if we have large numbers of small tasks
- Instead tasks can be executed by a pre-existing *pool* of threads
 - tasks are submitted to the pool
 - some thread in the pool executes the task
 - at some point in the future the task is guaranteed to have completed
- Tasks may or may not be ordered with respect to other tasks



Parallel loops

- Loops are the main source of parallelism in many applications.
- If the iterations of a loop are *independent* (can be done in any order) then we can share out the iterations between different threads.
- e.g. if we have two threads and the loop

```
for (i=0; i<100; i++){  
    a[i] += b[i];  
}
```

we could do iteration 0-49 on one thread and iterations 50-99 on the other.

- Can think of an iteration, or a set of iterations, as a task.



Reductions

- A *reduction* produces a single value from associative operations such as addition, multiplication, max, min, and, or.
- For example:

```
b = 0;  
for (i=0; i<n; i++)  
    b += a[i];
```

- Allowing only one thread at a time to update **b** would remove all parallelism.
- Instead, each thread can accumulate its own private copy, then these copies are reduced to give final result.
- If the number of operations is much larger than the number of threads, most of the operations can proceed in parallel

